

NMTLED52 series

A range of multiple lights for high-specification retail, hospitality and residential projects



CRI 90



APPLICATIONS

- Fashion retailing; jewellery, accessories and clothing
- Hotels and restaurants
- Luxury residential properties

Options

- **Body colour:** Rimmed versions available in a choice of white or silver grey. Rimless version available in black only
- **Beam angle:** Choice of 12°, 30° or 50°
- **CCT:** Choice of 3000K, 3500K or 4000K
- **Body style:** Rimmed (suffix A), rimmed adjustable (suffix C) or rimless (suffix B)

TECHNICAL DETAILS

- COB LEDs
- Rated life: 30,000 hours

CONSTRUCTION

- Aluminium body in a choice of finishes
- Extruded aluminium heat sink for excellent thermal performance and long life
- Three body styles, all for recessed installation:
 - Rimmed with fixed beam direction and spring clips
 - Rimmed with adjustable beam direction and spring clips. Rimless with fixed beam direction
- Constructed of multiple 3W modules assembled in units of 1, 2, 3, 4, 5 or 10 modules
- Cut-off angle of 35° for minimum glare
- product design allows units to be joined together seamlessly
- Separate driver included with each unit

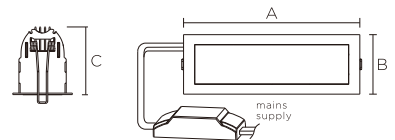

NMTLED52*A

| Model | A | B | C | Cut-out |
|-------|-----|----|----|---------|
| 3W | 50 | 48 | 55 | 43x40 |
| 2x3W | 81 | 48 | 55 | 74x40 |
| 3x3W | 112 | 48 | 55 | 105x40 |
| 4x3W | 143 | 48 | 55 | 136x40 |
| 5x3W | 174 | 48 | 55 | 167x40 |
| 10x3W | 330 | 48 | 55 | 320x40 |

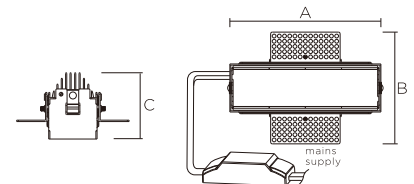

NMTLED52*B

| Model | A | B | C | Cut-out |
|-------|-----|----|----|---------|
| 3W | 37 | 97 | 57 | 40x46 |
| 2x3W | 68 | 97 | 57 | 70x46 |
| 3x3W | 99 | 97 | 57 | 101x46 |
| 4x3W | 130 | 97 | 57 | 132x46 |
| 5x3W | 160 | 97 | 57 | 163x46 |
| 10x3W | 318 | 97 | 57 | 319x46 |

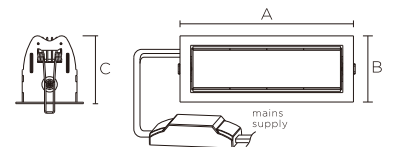

NMTLED52*C

| Model | A | B | C | Cut-out |
|-------|-----|----|----|---------|
| 3W | 53 | 56 | 56 | 47x47 |
| 2x3W | 84 | 56 | 56 | 78x47 |
| 3x3W | 116 | 56 | 56 | 109x47 |
| 4x3W | 147 | 56 | 56 | 140x47 |
| 5x3W | 178 | 56 | 56 | 171x47 |
| 10x3W | 334 | 56 | 56 | 327x47 |

| Model | Colour temp. | Lumens | CRI | PF | Beam angle |
|-------------------|-------------------|----------|-----|-------|-------------|
| NMTLED5201* 3W | 3000K/3500K/4000K | 160 lm | >90 | >0.45 | 12°/30°/50° |
| NMTLED5202* 2X3W | 3000K/3500K/4000K | 350 lm | >90 | >0.45 | 12°/30°/50° |
| NMTLED5203* 3X3W | 3000K/3500K/4000K | 530 lm | >90 | >0.9 | 12°/30°/50° |
| NMTLED5204* 4X3W | 3000K/3500K/4000K | 720 lm | >90 | >0.9 | 12°/30°/50° |
| NMTLED5205* 5X3W | 3000K/3500K/4000K | 970 lm | >90 | >0.9 | 12°/30°/50° |
| NMTLED5210* 10X3W | 3000K/3500K/4000K | 1,950 lm | >90 | >0.9 | 12°/30°/50° |

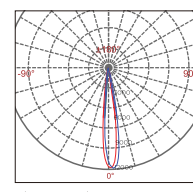

NMTLED5201A 3W 12°

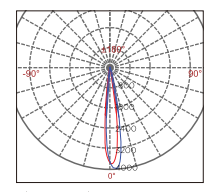

NMTLED5202B 2X3W 12°

Structure and details



High colour rendering index

CRI >90, The high CRI makes this fitting very suitable for high-end retail applications where very accurate colour rendering is required.

Low-glare characteristics

The NMTLED52 range offers a choice of beam angles, but all with excellent low-glare characteristics. Because the COB light source is deeply recessed inside the fitting body it is not easily visible, so whichever beam angle is chosen end-users benefit from glare-free lighting. This makes the fitting very suitable for a range of retail, hospitality and residential projects.

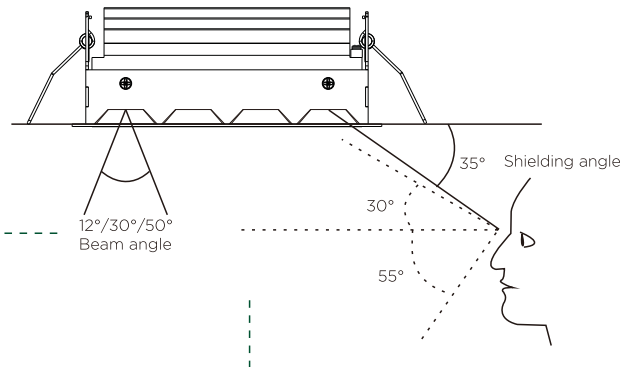

Compact size

The visible area can be as little as 48mm wide, making this exceptionally slim for a fitting of this type.

Viewing angles

When looking at an object in front of them a person's view is concentrated in the area from 55 degrees below the horizontal to 30 degrees above the horizontal. The NMTLED has a shielding angle of 35 degrees, so the viewer is protected from glare.

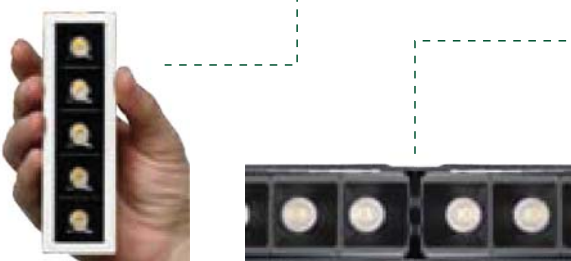

Easily joined together

Individual units can be installed end-to-end giving an almost seamless installation for a neater and more versatile effect.

Extruded aluminium heat sink

Each unit has an extruded aluminium heat sink. This provides each unit with its mechanical strength, so it is easier to install, and excellent heat dissipation properties so the COB LEDs remain cool and have a long service life.

Wide range of specifications

With three different body styles, six product lengths and three beam angles this range of products can be specified on a wide range of projects.

